

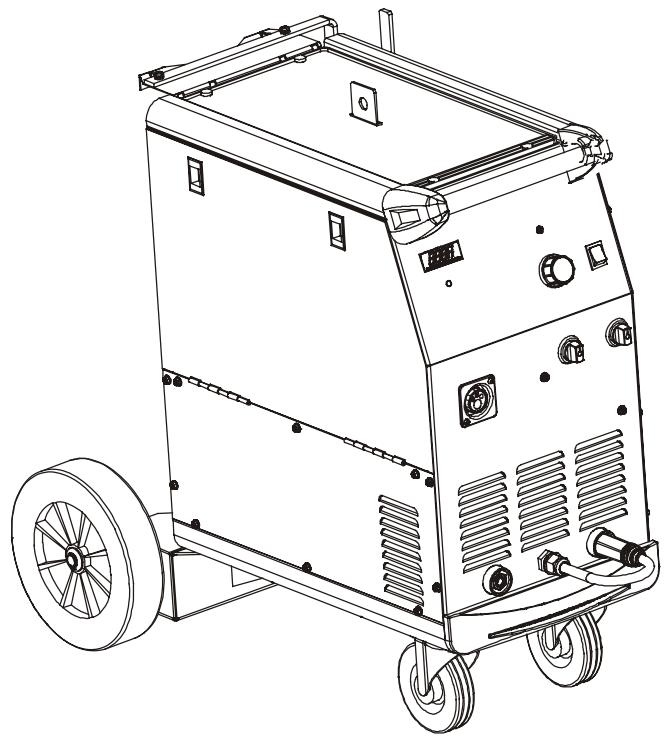

275 TRANSMIG POWER SOURCE



Operating Manual

Version No:2

Issue Date: March 2008

Manual No: 719547

Operating Features



CIGWELD

Professional

LEADER IN ARC WELDING TECHNOLOGY

We appreciate your business!

Congratulations on your new CIGWELD product. We are proud to have you as our customer and will strive to provide you with the best service and reliability in the industry. This product is backed by our extensive warranty and world-wide service network. To locate your nearest distributor or service agency call 1300-654-674, or visit us on the web at www.cigweld.com.au.

This Operating Manual has been designed to instruct you on the correct use and operation of your CIGWELD product. Your satisfaction with this product and its safe operation is our ultimate concern. Therefore please take the time to read the entire manual, especially the Safety Precautions. They will help you to avoid potential hazards that may exist when working with this product.

YOU ARE IN GOOD COMPANY

The Brand of Choice for Contractors and Fabricators. CIGWELD is the Market Leading Brand of Arc Welding Products for Thermadyne Industries Inc.

We are a mainline supplier to major welding industry sectors in the Asia Pacific and emerging global markets including; Manufacturing, Construction, Mining, Automotive, Engineering, Rural and DIY.

We distinguish ourselves from our competition through market leading dependable brands that have stood the test of time, technical innovation, competitive prices, excellent delivery, superior customer service and technical support, together with excellence in sales and marketing expertise.

We are committed to develop technologically advanced products to achieve a safer working environment for industry operators.



WARNING 1

*Read and understand this entire Manual and your employer's safety practices before installing, operating, or servicing the equipment.
While the information contained in this Manual represents the Manufacturer's best judgement, the Manufacturer assumes no liability for its use.*

Welding Power Supply
Instruction Manual Number 719547 for:

TRANSMIG 275	Power Source (Compact)	Spec Number	706116
TRANSMIG 275	Power Source (Remote)	Spec Number	706118

Published by:
CIGWELD Pty Ltd
71 Gower Street
Preston, Victoria, Australia, 3072

www.cigweld.com.au

Copyright 2007 by
CIGWELD

All rights reserved.

A reproduction of this work, in whole or in part, without written permission of the publisher is prohibited.

The publisher does not assume and hereby disclaims any liability to any party for any loss or damage caused by any error or omission in this Manual, whether such error results from negligence, accident, or any other cause.

Publication Date: **Oct 22, 2007**

Record the following information for Warranty purposes:

Where Purchased: _____

Purchase Date: _____

Equipment Serial #: _____

TRANSMIG 275 MIG Power Source

TABLE OF CONTENTS

SECTION 1:	Arc Welding Safety Instructions and Warnings.....	5
SECTION 2:	Introduction	10
SECTION 3:	Electromagnetic Compatibility	10
SECTION 4:	General Information	12
SECTION 5:	Safe Practices For The Use Of Welding Equipment.....	12
SECTION 6:	Resuscitation For Electric Shock Victims	14
SECTION 7:	Specifications	15
SECTION 8:	Installation Recommendations.....	16
SECTION 9:	Set up for the TRANSMIG 275 MIG Power Source.....	17
SECTION 10:	Wirefeeder Controls, Indicators and Features.....	19
SECTION 11:	Tweco MIG Torch OTWX412/3545 (where supplied).....	22
SECTION 12:	Basic Welding Technique	24
SECTION 13:	Routine Maintenance & Inspection	25
SECTION 14:	Basic Troubleshooting	26
SECTION 15:	Key Spare Parts	30
SECTION 16:	Volt / Amp Curves	30
SECTION 17:	Circuit Diagram	31
SECTION 18:	Weld Settings Guide	32

TABLES

Table 1 - Filter lens size verses welding current/electrode size	13
Table 2 – Power Source Specifications.....	15
Table 3 – Optional Accessories	16
Table 4 – Supply Requirements.....	17
Table 5 – Wire Spool parts.....	19
Table 6 – Interconnection Control Plug configuration	20
Table 7 – Mode Switch Functional Description	21
Table 8 – MIG Torch Components.....	22
Table 9 – MIG Torch Contact Tips	22
Table 10 – MIG Torch Nozzles	23
Table 11 – MIG Torch Conduits	23
Table 12 – MIG Torch Conductor Tubes	23
Table 13 – Electrode Wire Deposition Rate	24
Table 14 – Key Spare Parts	30

SECTION 1: Arc Welding Safety Instructions and Warnings



WARNING 2

ARC WELDING can be hazardous.

Protect yourself and others from possible serious injury or death. Keep children away. Pace maker wearers keep away until consulting your doctor. Do not lose these instructions. Read operating / instruction manual before installing, operating or servicing this equipment.

Welding products and welding processes can cause serious injury or death, or damage to other equipment or property, if the operator does not strictly observe all safety rules and take precautionary actions.

Safe practices have developed from past experience in the use of welding and cutting. These practices must be learned through study and training before using this equipment. Anyone not having extensive training in welding and cutting practices should not attempt to weld. Certain practices apply to equipment connected to power lines; other practices apply to engine driven equipment.

Safe practices are out lined in the American National Standard Z49.1 entitled: SAFETY IN WELDING AND CUTTING. This publication and other guides to what you should learn before operating this equipment are listed at the end of these safety precautions.

HAVE ALL INSTALLATION, OPERATION, MAINTENANCE, AND REPAIR WORK PERFORMED ONLY BY QUALIFIED PEOPLE.



ELECTRIC SHOCK can kill.

Touching live electrical parts can cause fatal shocks or severe burns. The electrode and work circuit is electrically live whenever the output is on. The input power circuit and machine terminal circuits are also live when power is on. In semiautomatic or automatic wire welding, the wire, wire reel, drive roll housing, and all metal parts touching the welding wire are electrically live. Incorrectly installed or improperly grounded equipment is a hazard.

1. Do not touch live electrical parts.
2. Wear dry, hole-free insulating gloves and body protection.
3. Insulate yourself from work and ground using dry insulating mats or covers.
4. Disconnect input power or stop engine before installing or servicing this equipment. Lock input power disconnect switch open, or remove line fuses so power cannot be turned on accidentally.
5. Properly install and ground this equipment according to its Owner's Manual and national, state, and 10 cal codes.



ARC RAYS can burn eyes and skin; NOISE can damage hearing.

Arc rays from the welding process produce intense heat and strong ultraviolet rays that can burn eyes and skin. Noise from some processes can damage hearing.

6. Turn off all equipment when not in use. Disconnect power to equipment if it will be left unattended or out of service.
7. Use fully insulated electrode holders. Never dip holder in water to cool it or lay it down on the ground or the work surface. Do not touch holders connected to two welding machines at the same time or touch other people with the holder or electrode.
8. Do not use worn, damaged, under sized or poorly spliced cables.
9. Do not wrap cables around your body.
10. Ground the workpiece to a good electrical (earth) ground.
11. Do not touch electrode while in contact with the work (ground) circuit.
12. Use only well-maintained equipment. Repair or replace damaged parts at once.
13. In confined spaces or damp locations, do not use a welder with AC output unless it is equipped with a voltage reducer. Use equipment with DC output.
14. Wear a safety harness to prevent falling if working above floor level.
15. Keep all panels and covers securely in place.
1. Wear a welding helmet fitted with a proper shade of filter (see ANSI 249.1 listed in Safety Standards) to protect your face and eyes when welding or watching.
2. Wear approved safety glasses. Side shields recommended.
3. Use protective screens or barriers to protect others from flash and glare; warn others not to watch the arc.
4. Wear protective clothing made from durable, flame-resistant material (wool and leather) and foot protection.
5. Use approved earplugs or earmuffs if noise level is high.

Eye protection filter shade selector for welding or cutting (goggles or helmet), from AWS A 8.2-73

Welding or Cutting operation	Electrode size Metal Thickness or Welding Current	Filter shade no.	Welding or Cutting operation	Electrode size Metal Thickness or Welding Current	Filter shade no.
Torch soldering	All	2	Gas metal arc welding		
Torch brazing	All	2 or 3	Non Ferrous base metal	All	11
Oxygen cutting			Ferrous base metal	All	12
Light	Under 1 in., 25 mm	3 or 4	Gas tungsten arc welding (TIG)	All	12
Medium	1 – 6 in., 25 – 150 mm	4 or 5	Atomic Hydrogen welding	All	12
Heavy	Over 6 in., 150 mm	5 or 6	Carbon Arc welding	All	12
Gas welding			Plasma arc Welding	All	12
Light	Under 1/8 in., 3 mm	4 or 5	Carbon Arc Gouging		
Medium	1/8 – 1/2 in., 3 – 12 mm	5 or 6	Light		12
Heavy	Over 1/2 in., 12 mm	6 or 8	Heavy		14
Shielded metal-arc welding (stick) electrodes			Plasma arc cutting		
	Under 5/32 in., 4 mm	10	Light	Under 300 Amp	9
	Under 5/32 to 1/4 in., 4 to 6.4mm	12	Medium	300 to 400 Amp	12
	Over 1/4 in., 6.4 mm	14	Heavy	Over 400 Amp	14

TRANSMIG 275 MIG Power Source



FUMES AND GASES can be hazardous to your health.

Welding produces fumes and gases. Breathing these fumes and gases can be hazardous to your health.

1. Keep your head out of the fumes. Do not breathe the fumes.
2. If inside, ventilate the area and/or use exhaust at the arc to remove welding fumes and gases.
3. If ventilation is poor, use an approved air-supplied respirator.
4. Read the Material Safety Data Sheets (MSDS) and the manufacturer's instruction for metals, consumables, coatings, and cleaners.

5. Work in a confined space only if it is well ventilated, or while wearing an air-supplied respirator. Shielding gases used for welding can displace air causing injury or death. Be sure the breathing air is safe.
6. Do not weld in locations near degreasing, cleaning, or spraying operations. The heat and rays of the arc can react with vapours to form highly toxic and irritating gases.
7. Do not weld on coated metals, such as galvanized lead, or cadmium plated steel, unless the coating is removed from the weld area, the area is well ventilated, and if necessary, while wearing an air supplied respirator. The coatings and any metals containing these elements can give off toxic fumes if welded.



WELDING can cause fire or explosion.

Sparks and spatter fly off from the welding arc. The flying sparks and hot metal, weld spatter, hot work piece, and hot equipment can cause fires and burns. Accidental contact of electrode or welding wire to metal objects can cause sparks, over heating, or fire.

1. Protect yourself and others from flying sparks and hot metal.
2. Do not weld where flying sparks can strike flammable material. Remove all flammables within 35ft (10.7 m) of the welding arc. If this is not possible, tightly cover them with approved covers.

3. Be alert that welding sparks and hot materials from welding can easily go through small cracks and openings to adjacent areas.
4. Watch for fire, and keep a fire extinguisher nearby.
5. Be aware that welding on a ceiling, floor, bulkhead, or partition can cause fire on the hidden side.
6. Do not weld on closed containers such as tanks or drums.
7. Connect work cable to the work as close to the welding area as practical to prevent welding current from travelling long, possibly unknown paths and causing electric shock and fire hazards.
8. Do not use welder to thaw frozen pipes.
9. Remove stick electrode from holder or cut off welding wire at contact tip when not in use.



Flying sparks and hot metal can cause Injury

Chipping and grinding cause flying metal. As welds cool, they can throw off slag.

1. Wear approved face shield or safety goggles. Side shields recommended.
2. Wear proper body protection to protect skin.



CYLINDERS can explode if damaged.

Shielding gas cylinders contain gas under high pressure. If damaged, a cylinder can explode. Since gas cylinders are normally part of the welding process, be sure to treat them carefully.

1. Protect compressed gas cylinders from excessive heat, mechanical shocks, and arcs.
2. Install and secure cylinders in an upright position by chaining them to a stationary support or equipment cylinder rack to prevent falling or tipping.
3. Keep cylinders away from any welding or other electrical circuits.

4. Never allow a welding electrode to touch any cylinder.
5. Use only correct shielding gas cylinders, regulators, hoses and fittings designed for the specific application; maintain them and associated parts in good condition.
6. Turn face away from valve outlet when opening cylinder valve.
7. Keep protective cap in place over valve except when cylinder is in use or connected for use.
8. Read and follow instructions on compressed gas cylinders, associated equipment, and CGA publication P-1 listed in Safety Standards.



WARNING 3

ENGINES can be dangerous.



ENGINE EXHAUST GASES can kill.

Engines produce harmful exhaust gases

1. Use equipment outside in open, well-ventilated areas.
2. If used in a closed area, vent engine exhaust outside and away from any building air intakes.



ENGINE FUEL can cause fire or explosion.

Engine fuel is highly flammable

1. Stop engine before checking or adding fuel.
2. Do not add fuel while smoking or if unit is near any sparks or open flames.

3. Allow engine to cool before fuelling. If possible, check and add fuel to cold engine before beginning job.
4. Do not overfill tank - allow room for fuel to expand away from any building air intakes.



MOVING PARTS can cause injury.

Moving parts, such as fans, rotors, and belts can cut fingers and hands and catch loose clothing.

1. Keep all doors, panels, covers, and guards closed and securely in place.
2. Stop engine before installing or connecting unit.

3. Have only qualified people remove guards or covers for maintenance and troubleshooting as necessary.
4. To prevent accidental starting during servicing, disconnect negative (-) battery cable from battery.
5. Keep hands, hair, loose clothing, and tools away from moving parts.
6. Re-install panels or guards and close doors when servicing is finished and before starting engine.



SPARKS can cause BATTERY GASES TO EXPLODE; BATTERY ACID can burn eyes and skin.

Batteries contain acid and generate explosive gases

1. Always wear a face shield when working on a battery.
2. Stop engine before disconnecting or connecting battery cables.
3. Do not allow tools to cause sparks when working on a battery.
4. Do not use welder to charge batteries or jump start vehicles.



STEAM AND PRESSURIZED HOT COOLANT can burn face, eyes, and skin.

The coolant in the radiator can be very hot and under pressure

1. Do not remove radiator cap when engine is hot. Allow engine to cool.
2. Wear gloves and put a rag over cap area when removing cap.
3. Allow pressure to escape before completely removing cap.

WARNING: This product, when used for welding or cutting, produces fumes or gases which contain chemicals known to the State of California to cause birth defects and, in some cases, cancer. (California Health & Safety Code Sec. 25249.5 et seq.)

NOTE: Considerations About Welding And The Effects Of Low Frequency Electric And Magnetic Fields

The following is a quotation from the General Conclusions Section of the U.S. Congress, Office of Technology Assessment, Biological Effects of Power Frequency Electric & Magnetic Fields Background Paper OTA-BP-E-63 (Washington, DC: U.S. Government Printing Office, May 1989): "... there is now a very large volume of scientific findings based on experiments at the cellular level and from studies with animals and people which clearly establish that low frequency magnetic fields can interact with, and produce changes in, biological systems. While most of this work is of very high quality, the results are complex. Current scientific understanding does not yet allow us to interpret the evidence in a single coherent framework. Even more frustrating, it does not yet allow us to draw definite conclusions about questions of possible risk or to offer clear science based advice on strategies to minimize or avoid potential risks."

To reduce magnetic fields in the work place, use the following procedures:

1. Keep cables close together by twisting or taping them.
2. Do not coil or drape cables around the body.
3. Arrange cables to one side and away from the operator.
4. Keep welding power source and cables as far away from body as practical.

About Pacemakers: The above procedures are among those also normally recommended for pacemaker wearers. Consult your doctor for complete information.

1.01 Publications

Refer to the following standards or their latest revisions for more information:

1. OSHA, SAFETY AND HEALTH STANDARDS, 29CFR 1910, obtainable from the Superintendent of Documents, U.S. Government Printing Office, Washington, D.C. 20402
2. ANSI Standard Z49.1, SAFETY IN WELDING AND CUTTING, obtainable from the American Welding Society, 550 N.W. LeJeune Rd, Miami, FL 33126
3. NIOSH, SAFETY AND HEALTH IN ARC WELDING AND GAS WELDING AND CUTTING, obtainable from the Superintendent of Documents, U.S. Government Printing Office, Washington, D.C. 20402
4. ANSI Standard Z87.1, SAFE PRACTICES FOR OCCUPATION AND EDUCATIONAL EYE AND FACE PROTECTION, obtainable from American National Standards Institute, 1430 Broadway, New York, NY 10018
5. ANSI Standard Z41.1, STANDARD FOR MEN'S SAFETY-TOE FOOTWEAR, obtainable from the American National Standards Institute, 1430 Broadway, New York, NY 10018
6. ANSI Standard Z49.2, FIRE PREVENTION IN THE USE OF CUTTING AND WELDING PROCESSES, obtainable from American National Standards Institute, 1430 Broadway, New York, NY 10018
7. AWS Standard A6.0, WELDING AND CUTTING CONTAINERS WHICH HAVE HELD COMBUSTIBLES, obtainable from American Welding Society, 550 N.W. LeJeune Rd, Miami, FL 33126

TRANSMIG 275 MIG Power Source

8. NFPA Standard 51, OXYGEN-FUEL GAS SYSTEMS FOR WELDING, CUTTING AND ALLIED PROCESSES, obtainable from the National Fire Protection Association, Batterymarch Park, Quincy, MA 02269
9. NFPA Standard 70, NATIONAL ELECTRICAL CODE, obtainable from the National Fire Protection Association, Batterymarch Park, Quincy, MA 02269
10. NFPA Standard 51B, CUTTING AND WELDING PROCESSES, obtainable from the National Fire Protection Association, Batterymarch Park, Quincy, MA 02269
11. CGA Pamphlet P-1, SAFE HANDLING OF COMPRESSED GASES IN CYLINDERS, obtainable from the Compressed Gas Association, 1235 Jefferson Davis Highway, Suite 501, Arlington, VA 22202
12. CSA Standard W117.2, CODE FOR SAFETY IN WELDING AND CUTTING, obtainable from the Canadian Standards Association, Standards Sales, 178 Rexdale Boulevard, Rexdale, Ontario, Canada M9W 1R3
13. NWSA booklet, WELDING SAFETY BIBLIOGRAPHY obtainable from the National Welding Supply Association, 1900 Arch Street, Philadelphia, PA 19103
14. American Welding Society Standard AWSF4.1, RECOMMENDED SAFE PRACTICES FOR THE PREPARATION FOR WELDING AND CUTTING OF CONTAINERS AND PIPING THAT HAVE HELD HAZARDOUS SUBSTANCES, obtainable from the American Welding Society, 550 N.W. LeJeune Rd, Miami, FL 33126
15. 15. ANSI Standard Z88.2, PRACTICE FOR RESPIRATORY PROTECTION, obtainable from American National Standards Institute, 1430 Broadway, New York, NY 10018

1.02 Declaration of Conformity

Manufacturer and Merchandiser of Quality Consumables and Equipment:

CIGWELD

Address:

71 Gower St, Preston

Victoria 3072

Australia



Description of equipment: Welding Equipment (GMAW). TRANSMIG 275 MIG Power Source and associated accessories.

- * Serial numbers are unique with each individual piece of equipment and details description, parts used to manufacture a unit and date of manufacture.
- * The equipment conforms to all applicable aspects and regulations of the 'Low Voltage Directive' (Directive 73/23/EU, as recently changed in Directive 93/68/EU and to the National legislation for the enforcement of the Directive.

National Standard and Technical Specifications

The product is designed and manufactured to a number of standards and technical requirements among them are:

- * AS/NZS 3652-(EMC Directive EN50199) applicable to arc welding equipment - generic emissions and regulations.
- * AS60974-1 2006 applicable to welding equipment and associated accessories.
- * UL-94V0 flammability rating for all Printed Circuit Boards used.
- * 92/31/EEC – EMC directive EN50199 applicable to Arc Welding Equipment – generic emissions and regulations.
- * Extensive product design verification is conducted at the manufacturing facility as part of the routine design and manufacturing process, to ensure the product is safe and performs as specified. Rigorous testing is incorporated into the manufacturing process to ensure the manufactured product meets or exceeds all design specifications.

CIGWELD has been manufacturing and merchandising an extensive equipment range with superior performance, ultra safe operation and world class quality for more than 30 years and will continue to achieve excellence.

1.03 Limited Warranty

LIMITED WARRANTY: CIGWELD, A Thermadyne Company, hereafter, "CIGWELD" warrants to customers of its authorized distributors hereafter "Purchaser" that its products will be free of defects in workmanship or material. Should any failure to conform to this warranty appear within the time period applicable to the CIGWELD products as stated below, CIGWELD shall, upon notification thereof and substantiation that the product has been stored, installed, operated, and maintained in accordance with CIGWELD's specifications, instructions, recommendations and recognized standard industry practice, and not subject to misuse, repair, neglect, alteration, or accident, correct such defects by suitable repair or replacement, at CIGWELD's sole option, of any components or parts of the product determined by CIGWELD to be defective.

CIGWELD MAKES NO OTHER WARRANTY, EXPRESS OR IMPLIED. THIS WARRANTY IS EXCLUSIVE AND IN LIEU OF ALL OTHERS, INCLUDING, BUT NOT LIMITED TO ANY WARRANTY OF MERCHANTABILITY OR FITNESS FOR ANY PARTICULAR PURPOSE.

LIMITATION OF LIABILITY: CIGWELD SHALL NOT UNDER ANY CIRCUMSTANCES BE LIABLE FOR SPECIAL, INDIRECT OR CONSEQUENTIAL DAMAGES, SUCH AS, BUT NOT LIMITED TO, LOST PROFITS AND BUSINESS INTERRUPTION. The remedies of the Purchaser set forth herein are exclusive and the liability of CIGWELD with respect to any contract, or anything done in connection therewith such as the performance or breach thereof, or from the manufacture, sale, delivery, resale, or use of any goods covered by or furnished by CIGWELD whether arising out of contract, negligence, strict tort, or under any warranty, or otherwise, shall not, except as expressly provided herein, exceed the price of the goods upon which such liability is based. No employee, agent, or representative of CIGWELD is authorized to change this warranty in any way or grant any other warranty.

PURCHASER'S RIGHTS UNDER THIS WARRANTY ARE VOID IF REPLACEMENT PARTS OR ACCESSORIES ARE USED WHICH IN CIGWELD'S SOLE JUDGEMENT MAY IMPAIR THE SAFETY OR PERFORMANCE OF ANY CIGWELD PRODUCT. PURCHASER'S RIGHTS UNDER THIS WARRANTY ARE VOID IF THE PRODUCT IS SOLD TO PURCHASER BY NON-AUTHORIZED PERSONS.

The warranty is effective for the time stated below beginning on the date that the authorized distributor delivers the products to the Purchaser. Notwithstanding the foregoing, in no event shall the warranty period extend more than the time stated plus one year from the date CIGWELD delivered the product to the authorized distributor.

Terms of Warranty – July 2007

- The Trade Practices Act 1974 (Commonwealth) and similar State Territory legislation relating to the supply of goods and services, protects consumers' interests by ensuring that consumers are entitled in certain situations to the benefit of various conditions, warranties, guarantees, rights and remedies (including warranties as to merchantability and fitness for purpose) associated with the supply of goods and services. A consumer should seek legal advice as to the nature and extent of these protected interests. In some circumstances, the supplier of goods and services may legally stipulate that the said conditions, warranties, guarantees, rights and remedies are limited or entirely excluded. The warranties set out in Clause 2 shall be additional to any non-excludable warranties to which the Customer may be entitled pursuant to any statute.
- Subject to Clause 3. CIGWELD gives the following warranties to the Customer:
Insofar as they are manufactured or imported by CIGWELD, goods will upon delivery be of merchantable quality and reasonably fit for the purpose for which they are supplied by CIGWELD.
CIGWELD will repair or, at its option, replace those of the goods which, upon examination, are found by CIGWELD to be defective in workmanship and/or materials.
CIGWELD reserves the right to request documented evidence of date of purchase.
- The Warranty in Clause 2:
Is conditional upon:
The Customer notifying CIGWELD or our Accredited Distributor in writing of its claim within seven (7) days of becoming aware of the basis thereof, and at its own expense returning the goods which are the subject of the claim to CIGWELD or nominated Accredited Distributor/Accredited Service Provider.
The goods being used in accordance with the Manufacturer's Operating Manuals, and under competent supervision.
Does not apply to:
Obsolete goods sold at auction, second-hand goods and prototype goods.
Breakdown or malfunction caused by accident, misuse or normal wear and tear.
Repairs or replacement made other than by CIGWELD or Accredited Service Providers, unless by prior arrangement with CIGWELD.
Replacement parts or accessories which may affect product safety or performance and which are not manufactured, distributed or approved by CIGWELD.
- CIGWELD declares that, to the extent permitted by law, it hereby limits its liability in respect of the supply of goods which are not of a kind ordinarily acquired for personal, domestic or household use or consumption to any one or more of the following (the choice of which shall be at the option of CIGWELD).
The replacement of the goods or the supply of equivalent goods.
The repair of goods.
The payment of cost of replacing the goods or acquiring equivalent goods.
The payment of the cost of having goods repaired.
- Except as provided in Clauses 2 to 4 above, to the extent permitted by statute, CIGWELD hereby excludes all liability for any loss, damage, death or injury of any kind whatsoever occasioned to the Customer in respect of the supply of goods including direct, indirect, consequential or incidental loss, damage or injury of any kind.

Warranty Schedule – January 2007

These warranty periods relate to the warranty conditions in clause 2. All warranty periods are from date of sale from the Accredited Distributor of the equipment. Notwithstanding the foregoing, in no event shall the warranty period extend more than the time stated plus one year from the date CIGWELD delivered the product to the Accredited Distributor. Unless otherwise stated the warranty period includes parts and labour.

CIGWELD reserves the right to request documented evidence of date of purchase.

<u>CIGWELD MIG WELDING EQUIPMENT</u>	<u>WARRANTY PERIOD</u>
TRANSMIG 275 MIG Power Source	
Original Main Power Rectifier, Main Power Magnetics, Control Printed Circuit Boards.....	3 years
All other circuits and components including, but not limited to, relays, switches, contactors, solenoids, fans, power switch semi-conductors	1 year
<u>ACCESSORIES</u>	
MIG torch (where fitted)	3 months
MIG torch consumable items	NIL

Please note that the information detailed in this statement supersedes any prior published data produced by CIGWELD.

TRANSMIG 275 MIG Power Source



WARNING 4

For the purpose of safety and performance and to protect your CIGWELD Equipment Warranty always use genuine CIGWELD replacement parts and accessories.

SECTION 2: Introduction

2.01 How to Use This Manual

This Owner's Manual usually applies to just the underlined specification or part numbers listed on the page 3. If none are underlined, they are all covered by this manual. To ensure safe operation, read the entire manual, including the chapter on safety instructions and warnings. Throughout this manual, the word **WARNING**, **CAUTION** and **NOTE** may appear. Pay particular attention to the information provided under these headings. These special annotations are easily recognized as follows:



WARNING

Gives information regarding possible personal injury. Warnings will be enclosed in a box such as this.

CAUTION

Refers to possible equipment damage. Cautions will be shown in bold type.

NOTE

Offers helpful information concerning certain operating procedures. Notes will be shown in italics.

2.02 Equipment Identification

The unit's identification number (specification or part number), model, and serial number usually appear on a nameplate attached to the machine.

Equipment which does not have a nameplate attached to the machine is identified only by the specification or part number printed on the shipping container. Record these numbers for future reference.

2.03 Receipt of Equipment

When you receive the equipment, check it against the invoice to make sure it is complete and inspect the equipment for possible damage due to shipping. If there is any damage, notify the carrier immediately to file a claim. Furnish complete information concerning damage claims or shipping errors to: CIGWELD, Customer Care Department, 71 Gower St, Preston, Victoria, Australia, 3072.

Include all equipment identification numbers as described above along with a full description of the parts in error.

Additional copies of this manual may be purchased by contacting CIGWELD, Customer Care Department, at the address given above. Include the Owner's Manual number and equipment identification numbers.

SECTION 3: Electromagnetic Compatibility



WARNING 5

Extra precautions for Electromagnetic Compatibility may be required when this Welding Power Source is used in a domestic situation.

3.01 Installation and use - Users Responsibility

The user is responsible for installing and using the welding equipment according to the manufacturer's instructions. If electromagnetic disturbances are detected then it shall be the responsibility of the user of the welding equipment to resolve the situation with the technical assistance of the manufacturer. In some cases this remedial action may be as simple as earthing the welding circuit, see NOTE 1. In other cases it could involve constructing an electromagnetic screen enclosing the Welding Power Source and the work, complete with associated input filters. In all cases, electromagnetic disturbances shall be reduced to the point where they are no longer troublesome.

NOTE 1

The welding circuit may or may not be earthed for safety reasons. Changing the earthing arrangements should only be authorised by a person who is competent to assess whether the changes will increase the risk of injury, e.g. by allowing parallel welding current return paths which may damage the earth circuits of other equipment. Further guidance is given in IEC 974-13 Arc Welding Equipment - Installation and use (under preparation).

3.02 Assessment of Area

Before installing welding equipment, the user shall make an assessment of potential electromagnetic problems in the surrounding area. The following shall be taken into account

- i) Other supply cables, control cables, signalling and telephone cables; above, below and adjacent to the welding equipment.
- ii) Radio and television transmitters and receivers.
- iii) Computer and other control equipment.
- iv) Safety critical equipment, e.g. guarding of industrial equipment.
- v) The health of people around, e.g. the use of pacemakers and hearing aids.
- vi) Equipment used for calibration and measurement.
- vii) The time of day that welding or other activities are to be carried out.
- viii) The immunity of other equipment in the environment: the user shall ensure that other equipment being used in the environment is compatible: this may require additional protection measures.

The size of the surrounding area to be considered will depend on the structure of the building and other activities that are taking place. The surrounding area may extend beyond the boundaries of the premises.

3.03 Methods of Reducing Electromagnetic Emissions

a) Mains Supply

Welding equipment should be connected to the mains supply according to the manufacturer's recommendations. If interference occurs, it may be necessary to take additional precautions such as filtering of the mains supply. Consideration should be given to shielding the supply cable of permanently installed welding equipment in metallic conduit or equivalent.

Shielding should be electrically continuous throughout its length. The shielding should be connected to the Welding Power Source so that good electrical contact is maintained between the conduit and the Welding Power Source enclosure.

b) Maintenance of Welding Equipment

The welding equipment should be routinely maintained according to the manufacturer's recommendations. All access and service doors and covers should be closed and properly fastened when the welding equipment is in operation. The welding equipment should not be modified in any way except for those changes and adjustments covered in the manufacturer's instructions. In particular, the spark gaps of arc striking and stabilising devices should be adjusted and maintained according to the manufacturer's recommendations.

c) Welding Cables

The welding cables should be kept as short as possible and should be positioned close together, running at or close to the floor level.

d) Equipotential Bonding

Bonding of all metallic components in the welding installation and adjacent to it should be considered. However, metallic components bonded to the work piece will increase the risk that the operator could receive a shock by touching the metallic components and the electrode at the same time. The operator should be insulated from all such bonded metallic components.

e) Earthing of the Workpiece

Where the workpiece is not bonded to earth for electrical safety, nor connected to earth because of its size and position, e.g. ship's hull or building steelwork, a connection bonding the workpiece to earth may reduce emissions in some, but not all instances. Care should be taken to prevent the earthing of the workpiece increasing the risk of injury to users, or damage to other electrical equipment. Where necessary, the connection of the workpiece to earth should be made by direct connection to the workpiece, but in some countries where direct connection is not permitted, the bonding should be achieved by suitable capacitance, selected according to national regulations.

f) Screening and Shielding

Selective screening and shielding of other cables and equipment in the surrounding area may alleviate problems of interference. Screening the entire welding installation may be considered for special applications.

TRANSMIG 275 MIG Power Source

SECTION 4: General Information

4.01 TRANSMIG 275 MIG Power Source

The TRANSMIG 275 MIG Power Source is a semi-automatic Gas Metal Arc Welder (GMAW-commonly MIG) with either an integrated or a separate wire feed unit. The Power Source is designed to meet the broad operating needs of the metal fabrication industry where production efficiency is vital. They are designed to meet the requirements of international standard EN60974-1 and Australian Standard AS60974-1.

The TRANSMIG 275 MIG Power Source gives excellent performance on mild steel, stainless steel, aluminium, silicon bronze and some hard facing wires with Argon based shielding gases. The Power Source also gives excellent results on mild steel using Carbon Dioxide shielding gas.

The TRANSMIG 275 MIG Power Source is supplied as a complete package ready to weld (apart from shielding gas, electrode wire and Hiderok TM welding helmet). The following instructions detail how to correctly set up the machine and give guidelines on gaining the best production efficiency from the Power Source. Please read these instructions thoroughly before using your welder.

4.02 User Responsibility

This equipment will perform as per the information contained herein when installed, operated, maintained and repaired in accordance with the instructions provided. This equipment must be checked periodically. Defective equipment (including welding leads) should not be used. Parts that are broken, missing, plainly worn, distorted or contaminated, should be replaced immediately. Should such repairs or replacements become necessary, it is recommended that such repairs be carried out by appropriately qualified persons approved by CIGWELD. Advice in this regard can be obtained by contacting accredited CIGWELD Distributor.

This equipment or any of its parts should not be altered from standard specification without prior written approval of CIGWELD. The user of this equipment shall have the sole responsibility for any malfunction which results from improper use or unauthorised modification from standard specification, faulty maintenance, damage or improper repair by anyone other than appropriately qualified persons approved by CIGWELD.

4.03 Duty Cycle

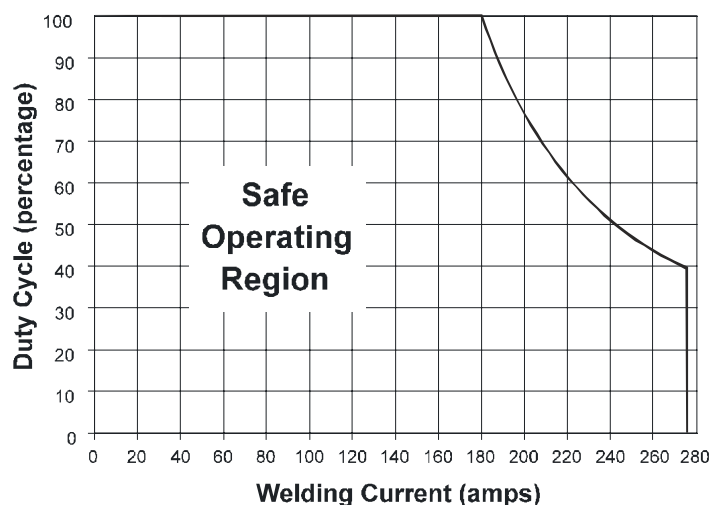

The rated duty cycle of a Welding Power Source, is a statement of the time it may be operated at its rated welding current output without exceeding the temperature limits of the insulation of the component parts. To explain the 10 minute duty cycle period the following example is used. Suppose a Welding Power Source is designed to operate at a 40% duty cycle, 275 amperes at 28 volts. This means that it has been designed and built to provide the rated amperage (275A) for 4 minutes, i.e. arc welding time, out of every 10 minute period (40% of 10 minutes is 4 minutes). During the other 6 minutes of the 10 minute period the Welding Power Source must idle and allowed to cool. The thermal cutout will operate if the duty cycle is exceeded.

SECTION 5: Safe Practices For The Use Of Welding Equipment

In many situations the "striking" voltage can be hazardous. Any person touching simultaneously the electrode lead/terminal and the work lead/terminal may receive a serious electrical shock. Additional precautions must be exercised where two Welding Power Sources are being used close to each other because, under certain conditions, the voltages between the welding terminals of the two Welding Power Sources could be two times the specified open circuit voltage.

It is essential that the Welding Power Source is correctly installed, if necessary, by a qualified electrician and maintained in sound mechanical and electrical condition. It is also important that the Welding Power Source be switched off when not in use.

5.01 Precautions to be Taken by Operators

- ◆ Whenever practicable, all parts of the welding circuit should be isolated from earth and other conducting material and under no circumstances should any earthing conductor of the electrical installation be used in place of the work lead.
- ◆ The Mains supply voltage should be switched off before connecting or disconnecting welding leads. Welding lead connections must have clean contact surfaces and must be securely tightened. Poor connections will result in overheating and loss of welding current. All parts of the welding circuit, including the return paths, are to be considered electrically alive, so the operator must ensure that no part of the body is placed in such a position that it will provide a path for an electric current.
- ◆ Welding operators should avoid direct contact with the work to be welded or against any metal in contact with the work. When this cannot be avoided the operator must not touch any exposed portion of the electrode holder with any part of the body. Should this occur, the operator will risk completing the electrical circuit through the body.
- ◆ When welding in confined spaces, where reasonable movement is restricted, particular care must be taken to ensure that the area is well ventilated and the operator is under constant observation by a person who can immediately switch off the power and give assistance in an emergency.
- ◆ The flux covering of an electrode cannot be assumed to provide effective insulation, consequently an insulating glove must be worn when placing an electrode into its holder, or should it be necessary to handle an electrode once it is in contact with its holder.
- ◆ During pauses between welding runs, electrode holders, TIG torches and MIG torches should be so placed that they cannot make electrical contact with persons or conductive objects.
- ◆ The welding leads, both the electrode lead, TIG torch lead or MIG torch lead and the work lead, must be protected from damage. Damaged leads must not be used.
- ◆ Keep combustible materials away from the welding area. Have a suitable fire extinguisher handy.
- ◆ Do not stand on damp ground when welding.

5.02 Personal Protection

The radiation from an electric arc during the welding process can seriously harm eyes and skin. It is essential that the following precautions be taken:

- ◆ Gloves should be flameproof gauntlet type to protect hands and wrists from heat burns and harmful radiations. They should be kept dry and in good repair.
- ◆ Protective clothing must protect the operator from burns, spatter and harmful radiation. Woollen clothing is preferable to cotton because of its greater flame resistance. Clothing should be free from oil or grease. Wear leggings and spats to protect the lower portion of the legs and to prevent slag and molten metal from falling into boots or shoes.
- ◆ Welding Faceshield

It is a requirement to use a welding Faceshield, complying to a relevant standard, when electric arc welding. Use a welding Faceshield in serviceable condition and fitted with an eye filter lens to safely reduce harmful radiation from the arc as per Table 1.

Welding Process	Welding current range	Suggested Filter Lens
GMAW	40 – 150A	Shade 10
GMAW	150 – 250A	Shade 11
GMAW	250 – 300A	Shade 12
GMAW	300 – 400A	Shade 13
GMAW	Over 400A	Shade 14

Table 1 - Filter lens size verses welding current/electrode size

Protective filter lenses are provided to reduce the intensity of radiation entering the eye thus filtering out harmful infra-red, ultra-violet radiation and a percentage of the visible light. Such filter lenses are incorporated within welding handshields. To prevent damage to the filter lenses from molten or hard particles an additional hard clear glass or special plastic external cover lens is provided. This cover lens should always be kept in place and replaced before the damage impairs your vision while welding.

Notes:

- ◆ Recognised standards for recommended practices for occupational eye protection include AS/ANZ 1336 and EN 175.
- ◆ For maximum possible protection, the use of full helmet equipment is recommended.
- ◆ The indicated filter lens shade numbers are minimum. If any discomfort is felt, higher shade numbers (i.e. darker filters) should be used.

TRANSMIG 275 MIG Power Source

SECTION 6: Resuscitation For Electric Shock Victims

Electric shock may kill immediately. Early resuscitation is required if a life is to be saved. Every Second Counts! Electrical currents may:

- ◆ Stop the heart;
- ◆ Cause contraction of the muscles of the body;
- ◆ Paralyse breathing due to paralysis of the centre of respiration in the brain;
- ◆ Cause burns.

The victims often cannot free themselves from the current and may not be able to breathe due to fixation of the chest.

6.01 Resuscitation

Efficient resuscitation requires training which is available from the St John's Ambulance Association, Red Cross and other sources.

- 1 Don't become a victim. Switch off power if possible. If not, remove victim from contact, using some insulating material.

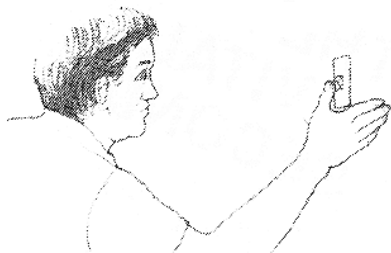

- 2 If unconscious, place victim on their side and clear vomit and other foreign matter from mouth. Check for breathing by look, listen and feel. If not breathing, commence expired air resuscitation (E.A.R.). This should take no longer than 3 or 4 seconds.



- 3 Place victim flat on their back on a hard surface, open airway - using head tilt and jaw support as shown.



- 4 Begin artificial breathing - 5 full breaths in 10 seconds, sealing nostrils with cheek or holding nose closed.



- 5 Check carotid pulse in neck. If pulse is present, continue E.A.R.
15 breaths per minute for adults.
20 breaths per minute for children.



- 6 If pulse is absent and you have been trained, begin cardio pulmonary resuscitation (C.P.R).
Cardiac Compression - depress lower end of breast bone (sternum) 4cm to 5cm, less for small children.
One rescuer - 2 breaths, 15 compressions in 15 seconds, i.e. 4 cycles per minute.
Two rescuers - 1 breath, 5 compressions in 5 seconds, i.e. 12 cycles per minute.



- 7 Check for return of pulse and breathing after 1 minute and at least every 2 minutes. Continue uninterrupted until trained assistance is available. When breathing and pulse return, turn on side and continue observation.

TRANSMIG 275 MIG Power Source

SECTION 7: Specifications

7.01 TRANSMIG 275 MIG Power Source Specifications

Description (Refer NOTE 2)	TRANSMIG 275 MIG Power Source	
	COMPACT	REMOTE
Plant Assembly	706116	706118
Plant Mass	103 kg	113 kg
Plant Dimensions (including cylinder carrier & excluding wheels)	H 826mm x W 496mm x D 916mm	
Power Source Part Number	707514	707515
Power Source Mass	93 kg	89 kg
Maximum Inlet Gas Pressure	1.2 MPa (gas hose)	1.2 MPa (gas hose)
Suitable Gas Types	Argon based mixed gases & CO2	Argon based mixed gases & CO2
Interconnection control plug	N / A	7 pin

Description (Refer NOTE 2)	TRANSMIG 275 MIG Power Source	
	240 VAC (15A fitted supply lead)	240 VAC (6mm ² supply lead)
Number of Phases & Frequency	1 phase 50 / 60 Hz	
Rated Input Current @ 100% Duty Cycle	▽ 15A	▽ ⚡ 31A
Rated kVA @ 100% Duty Cycle	4 kVA	7.5 kVA
Maximum Input Current	31A	56A
Generator Requirements	♣ 9 kVA	♣ 14 kVA
Supply VA @ no load	900 VA	900 VA
Supply VA @ max. output	8 kVA	13.5 kVA
Power Factor @ max. output	0.85	0.85
Rated Outlet Maximum Duty Cycle	32A	50A
Recommended Fuse Size	♣ 32A	♣ 50A
Open Circuit Voltage Range	15 to 40V	15 to 40V
Output Current Range	30 – 190A	30 – 275A
Rated Output Duty Cycle	190A@ 23%	275A@ 40%
100% Duty Cycle Output Rating	110A	180A
Operating Temperature Range	0°C - 40°C	0°C - 40°C
Duty Cycle Period	10 minutes	10 minutes
Number of Output Voltage Switch Settings	24	24
Wire Size Range	Hard Wire: 0.6mm - 1.2mm Soft Wire: 0.9mm - 1.6mm Fluxcored Wire: 0.8mm - 1.2mm	

Table 2 – Power Source Specifications

- ▽ The Rated Input Current should be used for the determination of cable size & supply requirements.
- ⚡ To achieve these ratings, the 15 Amp plug and lead (as supplied) must be replaced with a larger plug and lead. This must be carried out by a qualified electrical tradesperson.
- ♣ Motor start fuses or thermal circuit breakers are recommended for this application. Check local requirements for your situation in this regard.
- ♣ Generator Requirements at the Maximum Output Duty Cycle.

NOTE 2

Due to variations that can occur in manufactured products, claimed performance, voltages, ratings, all capacities, measurements, dimensions and weights quoted are approximate only. Achievable capacities and ratings in use and operation will depend upon correct installation, use, applications, maintenance and service.

TRANSMIG 275 MIG Power Source

7.02 Optional Accessories

Part Number	Description
OTWX412/3545	TWECO #4 torch, 3.6 metre EURO
OTWX415/3545	TWECO #4 torch, 4.5 metre EURO
7977729	Feed Roll 0.6 / 0.8 HARD
7977703	Feed Roll 0.9 / 1.2 HARD
7977346	Feed Roll 1.2 / 1.6 HARD
7977733	Feed Roll 0.8 / 0.9 SOFT
7977730	Feed Roll 1.0 / 1.2 SOFT
7977348	Feed Roll 1.2 / 1.6 SOFT
7977734	Feed Roll 0.8 / 0.9 CORED
7977347	Feed Roll 1.2 / 1.6 CORED
706744	Digital Meter Kit
705000	MIG pliers (size No 1)
705001	MIG pliers (size No 2)
646265	Weld measurement gauge

Table 3 – Optional Accessories

NOTE 3

Two feedrolls are required for each electrode wire size used

SECTION 8: Installation Recommendations

8.01 Environment

These units are not designed for use in environments with increased hazard of electric shock.

- a) Examples of environments with increased hazard of electric shock are -
- In locations in which freedom of movement is restricted, so that the operator is forced to perform the work in a cramped (kneeling, sitting or lying) position with physical contact with conductive parts;
 - In locations which are fully or partially limited by conductive elements, and in which there is a high risk of unavoidable or accidental contact by the operator, or
 - In wet or damp hot locations where humidity or perspiration considerable reduces the skin resistance of the human body and the insulation properties of accessories.
- b) Environments with increased hazard of electric shock do not include places where electrically conductive parts in the near vicinity of the operator, which can cause increased hazard, have been insulated.

8.02 Location

Be sure to locate the welder according to the following guidelines:

- In areas, free from moisture and dust.
- Ambient temperature between 0° C to 40° C.
- In areas, free from oil, steam and corrosive gases.
- In areas, not subjected to abnormal vibration or shock.
- In areas, not exposed to direct sunlight or rain.
- Place at a distance of 300mm or more from walls or similar that could restrict natural air flow for cooling.

8.03 Ventilation

Since the inhalation of welding fumes can be harmful, ensure that the welding area is effectively ventilated.

8.04 Mains Supply Voltage Requirements

The Mains supply voltage should be within $\pm 10\%$ of the rated Mains supply voltage. Too low a voltage may cause poor welding performance. Too high a supply voltage will cause components to overheat and possibly fail.

The Welding Power Source must be:

- ◆ Correctly installed, if necessary, by a qualified electrician.
- ◆ Correctly earthed (electrically) in accordance with local regulations.
- ◆ Connected to the correct size power point and fuse for each Power Source as per the Specifications on page 15.

The TRANSMIG 275 MIG Power Source is supplied with a 15 Amp input lead.

The TRANSMIG 275 MIG Power Source is factory connected for 240 VAC supply voltage:

The TRANSMIG 275 MIG Power Source is suitable for the following Mains supply voltages:

Mains Supply Voltage Setting	Mains Supply Lead Size	Minimum Mains Current Circuit Size	Fuse Size	Machines Duty Cycle
240V	6.0 mm ²	50 Amp	▲ 50Amp	275A @ 40%

Table 4 – Supply Requirements

SECTION 9: Set up for the TRANSMIG 275 MIG Power Source

9.01 Power Source Connections

- a) Remove all packaging materials.
- b) Connect the work lead to the negative welding terminal (-) [positive welding terminal (+) for flux cored electrode wire]. If in doubt, consult the electrode wire manufacturer.
- c) Position a gas cylinder on the rear tray of the Power Source and lock securely to the Power Source cylinder bracket with the chain provided. If this arrangement is not used or the Power Source is not fitted with a gas cylinder tray then ensure that the gas cylinder is secured to a building pillar, wall bracket or otherwise securely fixed in an upright position.

9.02 Wirefeeder Connections (Remote models only)

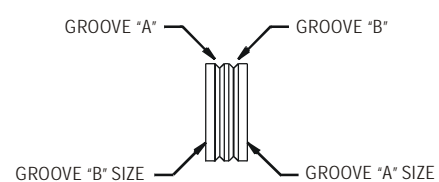
- a) Connect the welding power cable from the Wirefeeder's interconnection cables to the positive welding terminal (+) [negative welding terminal (-) for flux cored electrode wire]. If in doubt, consult the electrode wire manufacturer.
- b) Connect the control cable from the Wirefeeder to the socket on the Power Source.
- c) Fit the gas regulator and flowmeter to the gas cylinder then connect the gas hose from the rear of the Wirefeeder to the Flowmeter outlet.
- d) Dual groove feed rollers are supplied as standard. They can accommodate 0.9 / 1.2 diameter hard wires. Select the roller required with the chosen wire size marking facing outwards.
 
- e) Fit the electrode wire spool to the wire reel hub. Ensure that the drive dog-pin engages the mating hole in the wire spool. Push the 'R' clip into place to retain the wire spool securely. The electrode wire should feed from the bottom of the spool.
- f) MIG Torch, EURO MIG Torch Connection
Fit the MIG Torch to the Wirefeeder by pushing the torch connector into the brass torch adaptor and screwing the plastic torch nut clockwise to secure the torch to the torch adaptor. Remove the contact tip from the torch handset.

9.03 Wirefeeder Connections (Compact models only)

- a) Connect the TORCH power cable to the positive welding terminal (+) [negative welding terminal (-) for flux cored electrode wire]. If in doubt, consult the electrode wire manufacturer.

TRANSMIG 275 MIG Power Source

- b) Fit the gas regulator and flowmeter to the gas cylinder then connect the gas hose from the rear of the Power Source to the Flowmeter outlet.
- c) Dual groove feed rollers are supplied as standard. They can accommodate 0.9 / 1.2 diameter hard wires. Select the roller required with the chosen wire size marking facing outwards.
- d) Fit the electrode wire spool to the wire reel hub. Ensure that the drive dog-pin engages the mating hole in the wire spool. Push the 'R' clip into place to retain the wire spool securely. The electrode wire should feed from the bottom of the spool.
- e) MIG Torch, EURO MIG Torch Connection
Fit the MIG Torch to the Power Source by pushing the torch connector into the brass torch adaptor and screwing the plastic torch nut clockwise to secure the torch to the torch adaptor. Remove the contact tip from the torch handset.

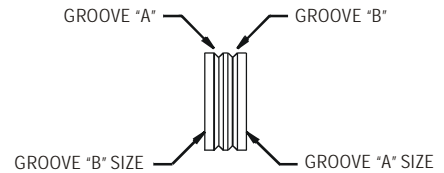

9.04 Common Connections

- a) Lift up the wire feeder pressure levers and pass the electrode wire through the inlet guide, between the rollers, through the centre guide, between the rollers, through the outlet guide and into the MIG torch.
- b) Lift up the wire feeder pressure levers and pass the electrode wire through the inlet guide, between the rollers, through the centre guide, between the rollers, through the outlet guide and into the MIG torch.



WARNING 6

DO NOT WEAR GLOVES WHILE THREADING THE WIRE OR CHANGING THE WIRE SPOOL.

- c) Lower the pressure levers and with the torch lead reasonably straight, feed the electrode wire through the torch. Fit the appropriate contact tip, eg a 0.9mm tip for 0.9mm wire.
- d) Press the Torch switch to feed the wire through the torch.



WARNING 7

The electrode wire will be at welding voltage potential whilst it is being fed through the wirefeeder system if the wire is fed by using the TORCH SWITCH

9.05 Drive Roller Pressure Adjustment (TRANSMIG 275 4 Roll Wirefeeder)

The moveable rollers apply pressure to the grooved feed rollers via a scaled adjustable tension screw. These devices should be adjusted to a minimum pressure that will provide satisfactory WIREFEED without slippage. If slipping occurs, and inspection of the wire contact tip reveals no wear, distortion or burn back jam, the conduit liner should be checked for kinks and clogging by metal flakes and swarf. If it is not the cause of slipping, the feedroll pressures can be increased by rotating the scaled tension screws clockwise. The use of excessive pressure may cause rapid wear of the feed rollers, shafts and bearing.

9.06 Wire Reel Brake (TRANSMIG 275 4 Roll Wirefeeder)

The wire reel hub incorporates a friction brake which is adjusted during manufacture for optimum breaking. If it is considered necessary, adjustment can be made by turning the large nut inside the open end of the hub clockwise to tighten the brake. Correct adjustment will result in the wire reel circumference continuing no further than 20mm after release of the trigger. The electrode wire should be slack without becoming dislodged from wire spool

CAUTION 1

Overtension of brake will cause rapid wear of mechanical WIREFEED parts, overheating of electrical componentry and possibly an increased incidence of electrode wire Burnback into contact tip

9.07 Wire Reel Hub Assembly (TRANSMIG 275 4 Roll Wirefeeder)

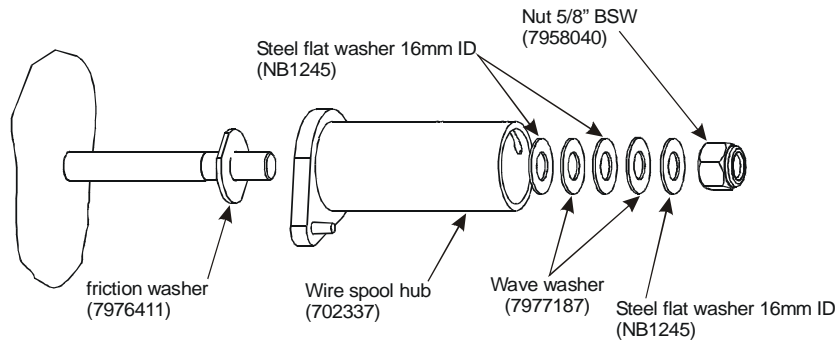

Item Number	Part Number / Description
1	7976411 / friction Washer
2	NB1245 / washer flat M16
3	7977187 / washer wave M16
4	7958040 / nut nyloc 5/8 BSW
--	702337 / Hub

Table 5 – Wire Spool parts

SECTION 10: Wirefeeder Controls, Indicators and Features

TRANSMIG 275 COMPACT

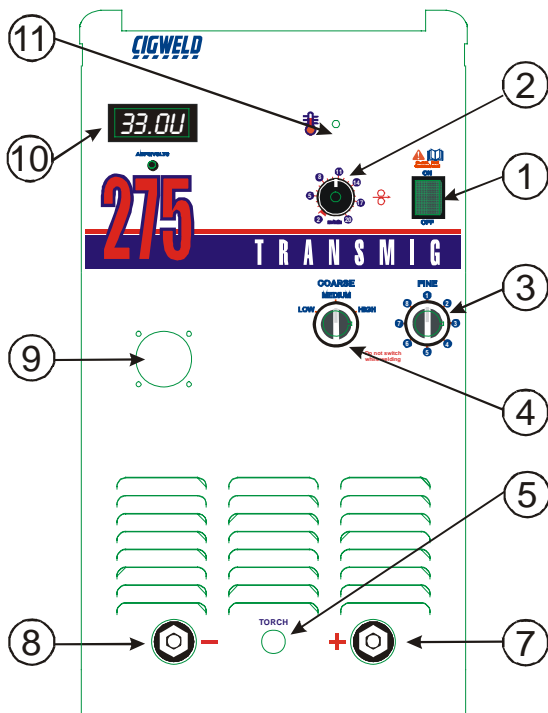

TRANSMIG 275 REMOTE

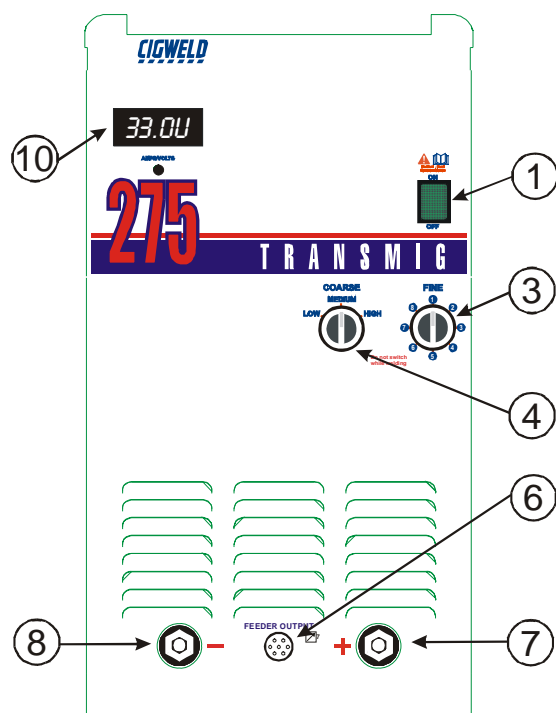

10.01 Standby switch with in-built Indicator Light

The indicator light is provided to indicate when the TRANSMIG 275 MIG Power Source is connected to the Mains Supply voltage. With the switch in the STANDBY position, the auxiliary power and the fan are turned off.



WARNING 8

When the light is lit, the machine is connected to the Mains supply voltage and the internal electrical components are at Mains voltage potential.

TRANSMIG 275 MIG Power Source

10.02 Wirespeed Control (Compact model only)

The Wirespeed Control knob controls the welding current via the electrode wirefeed rate. ie the speed of the wirefeed motor.

10.03 Fine Voltage Control Switch

The Fine Voltage Control switch increases the voltage (in smaller increments than the Coarse switch) as it is rotated in the clockwise direction.

10.04 Coarse Voltage Control Switch

The Coarse Voltage Control increases the voltage (in larger increments than the Fine switch) as it is rotated in the clockwise direction.

CAUTION 2

*The Coarse & Fine Voltage Control switches **MUST NOT BE SWITCHED** during the welding process*

10.05 Torch Polarity Lead (Compact model only)

This lead selects the welding voltage polarity of the electrode wire. Plug it into the positive welding terminal (+) when using steel, stainless steel or aluminium electrode wire. Plug the Torch Polarity Lead into the negative welding terminal (-) when using gasless electrode wire. If in doubt, consult the manufacturer of the electrode wire for the correct polarity.

10.06 Wirefeeder Control Socket (Remote model only)

The WIREFEEDER 7 pin receptacle is used to connect a Wirefeeder to the welding Power Source circuitry:

To make connections, align keyway, insert plug, and rotate threaded collar fully clockwise. The socket information is included in the event the supplied cable is not suitable and it is necessary to wire a plug or cable to interface with the WIREFEEDER7-pin receptacle.

Socket Pin	Part Number / Description
1	Output to energise the power supply contactor (Contact closure is provided between socket pins 1 and 2 to energise the contactor)
2	24 VAC Active
3	Power Source Thermostats
4	Power Source Thermostats
5	24 VAC Neutral
6	Power source welding voltage - Negative
7	Power source welding voltage - Positive

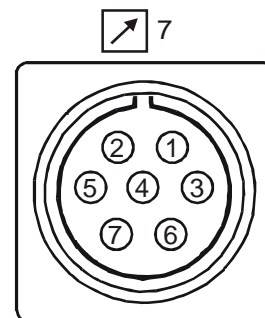

Table 6 – Interconnection Control Plug configuration

10.07 Positive Welding Terminal

Positive Welding Terminal. Welding current flows from the Power Source via heavy duty bayonet type terminals. It is essential, however, that the male plug is inserted and turned securely to achieve a sound electrical connection.

10.08 Negative Welding Terminal

Negative Welding Terminal. Welding current flows from the Power Source via heavy duty bayonet type terminals. It is essential, however, that the male plug is inserted and turned securely to achieve a sound electrical connection.

CAUTION 3

Loose welding terminal connections can cause overheating and result in the male plug being fused in the terminal.

10.09 Torch Connector

The MIG torch connects to this outlet.

10.10 Digital Ammeter and Voltmeter (where fitted)

Where fitted an average reading ammeter and voltmeter is provided to allow accurate monitoring (5% tolerance) of welding current and voltmeter to facilitate precise welding condition adjustment. The Digital Meter toggles between display of welding current and welding voltage. Press the button below the Digital Meter to toggle between the readings displayed

The Digital Meter will hold the last reading at completion of welding for 10 seconds to allow for easy operator set up.

Value displayed for 23.4 Volts

Value displayed for 157 Amp

23.4

157

10.11 Thermal Overload

The critical component for thermal protection is the rectifier stack, which is fitted with a thermal overload cut out device. If the overload operates then the machine should be left to cool for approximately 15 minutes before resuming welding. The thermal overload will not operate and there will be no danger of transformer damage if the Power Source is operated within its duty cycle.

The TRANSMIG 275 Compact Power Source has a front panel indication of Thermal Overload. For the TRANSMIG 275 Remote Power Source, the Thermal Overload indication is provided on the front panel of the TRANSMIG 275 4 Roll Wirefeeder.

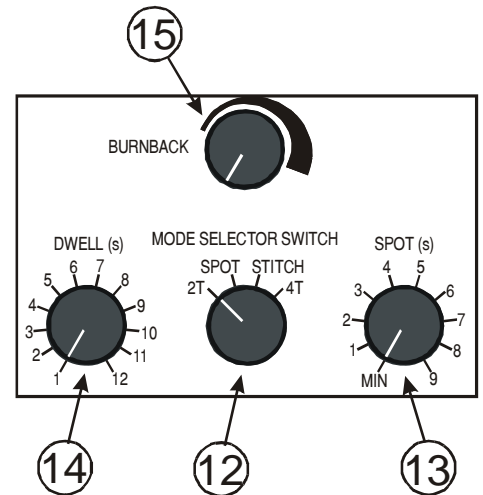

10.12 Mode Switch (Compact model only)

The Mode Selector switch selects the method of welding mode.

Mode	Functional Description
CONTINUOUS (2T)	This mode of welding is used to weld two or more components together with a continuous weld.
SPOT	This mode of welding is used to weld two plates together at a desired location by melting the top & bottom plates together to form a nugget between them. The spot time period is set by the SPOT TIME control shaft located in the electrode wire compartment.
STITCH	This mode of welding is used to weld two or more components together with a stitch weld. The SPOT TIME shaft controls the welding or 'ON' time whilst the DWELL TIME shaft controls the interval or 'OFF' time for stitch welding.
LATCH (4T)	This mode of welding is mainly used for long weld runs, as the operator need only press the trigger to activate the weld, then press the trigger again to stop. This obviates the need for the operator to depress the trigger for the complete length of the weld run.

Table 7 – Mode Switch Functional Description

10.13 Spot Timer (Compact model only)

With the MODE SELECTOR switch is switched to the SPOT position, the SPOT TIME shaft controls the duration of a single spot weld.

With the MODE SELECTOR switch is switched to the STITCH position, the SPOT TIME shaft controls the welding or 'ON' time whilst stitch welding.

10.14 Dwell Timer (Compact model Only)

The DWELL TIME knob controls the interval or 'OFF' time whilst stitch welding.

10.15 Burnback (Compact model Only)

Burnback time is the difference between the wirefeed motor stopping and switching off of the welding current. The Burnback time allows the electrode wire to burn out of the molten metal weld pool. The Burnback time is factory set for optimum performance.

Clockwise adjustment increases Burnback time.

TRANSMIG 275 MIG Power Source

SECTION 11: Tweco MIG Torch OTWX412/3545 (where supplied)

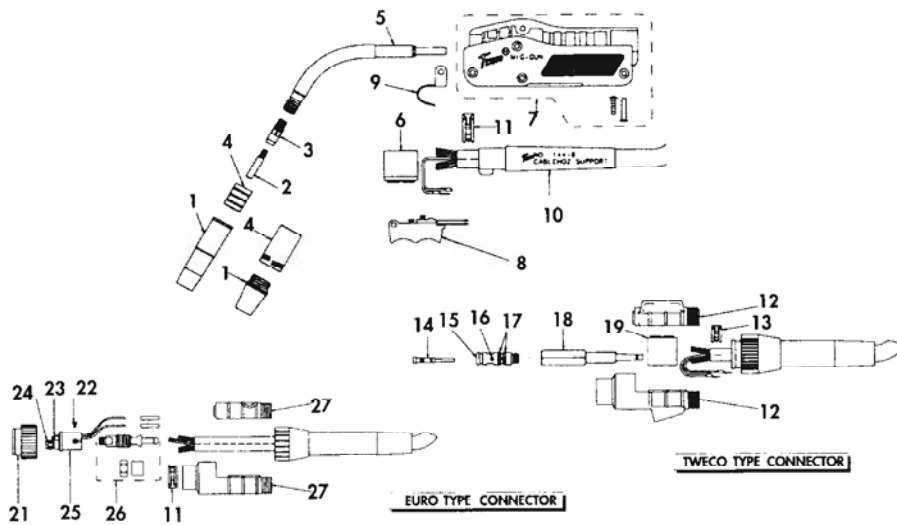

11.01 MIG Torch Components

Item	Part No.	Description	Qty
1	—	Nozzle (refer to Table 10)	1
2	—	Contact tip (refer to Table 9)	1
3	OTW54A	Gas diffuser	1
4	OTW34A	Insulator	1
5	—	Conductor Tube (refer to Table 12)	1
6	OTW104	Power Connector	1
7	OTW84A	Handle	1
8	OTW94R	Trigger Assembly	1
9	OTW154	Gun Hanger	1
10	OTW144/12	Front Cable Support	1
11	OTW134/14	Front Cable Clamp	1
21	OTW174X/2	Connector Nut	1
22	OTW4M/S	Screw	1
23	OTW174EX/1G	O-Ring	1
24	OTW174EX/1C	Conduit Cap	1
25	OTW174EX/1	Rear Connector	1
26	OTW172X/M	Power Connection	1
27	OTWC6RC	Rear Case	1
28	—	Conduit (refer to Table 11)	1

Table 8 – MIG Torch Components

11.02 MIG Torch Contact Tips

STANDARD & TAPERED

Wire Size	Part No.
0.6mm (.024")	OTW14/23
0.8mm (.030")	OTW14/30
0.9mm (.035")	OTW14/35
1.0mm (.040")	OTW14/40
1.2mm (.045")	OTW14/45
0.8mm (.030") Taper	OTW14T/30
0.9mm (.035") Taper	OTW14T/35
1.2mm (.045") Taper	OTW14T/45

HEAVY DUTY

Wire Size	Part No.
0.9mm (.035")	OTW14H/35
1.0mm (.040")	OTW14H/40
1.2mm (.045")	OTW14H/45
1.2mm (.045") ALUM	717256

Table 9 – MIG Torch Contact Tips

11.03 MIG Torch Nozzles

Bore Size	Part No.	Type
12.7mm (1/2")	OTW24A/50	Adjustable Tip
15.9mm (5/8")	OTW23/62F	Flush Tip
15.9mm (5/8")	OTW24A/62	Adjustable Tip
15.9mm (5/8")	OTW24AH/62	Adjustable Heavy Duty Tip
15.9mm (5/8")	717532	Fixed 3mm Recessed Tip
15.9mm (5/8")	717534	Fixed 13mm Recessed Tip
-	717540	Fixed Insulator for CT Nozzle
19.1mm (3/4")	OTW24AH/75	Adjustable Heavy Duty Tip

F = Flush Tip A = Adjustable Tip AH = Adjustable Heavy Duty Tip

Table 10 – MIG Torch Nozzles

11.04 MIG Torch Conduits

HARD ELECTRODE WIRE

Wire Size	Part No.
0.9-1.2mm (.035"-.045") 4.5me	OTW45/3545
1.6mm (.060") 4.5me	OTW44/116
0.9-1.2mm (.035"-.045") 7.6me	717344

SOFT ELECTRODE WIRE

Wire Size	Part No.
0.9-1.2mm (.035"-.045") 4.5me	717347
1.6mm (.060") 4.5me	OTW44N/116

Table 11 – MIG Torch Conduits

11.05 MIG Torch Conductor Tubes

Part No.
OTW64A/45
OTW64A/60

Part No.
OTW64J/45
OTW64J/60

Table 12 – MIG Torch Conductor Tubes

11.06 Installing a new Wire Conduit

- a) Be sure the MIG Torch cable is arranged in a straight line, free from twists, when installing or removing a wire conduit. Remove the old conduit by first removing the conduit retaining nut, MIG Torches nozzle, contact tip and gas diffuser. Pull the old wire conduit out of the cable assembly from the connector plug end.
- b) To install a new wire conduit, first inspect the o-ring gas seal on the conduit for cuts or damage. Start from the connector plug end of the assembly and begin pushing the conduit through the connector plug, cable assembly and into the torch. If the conduit should lodge along the way, gently whip or work the cable assembly to aid forward movement.
- c) When the wire conduit stop meets the end of the connector plug and the new raw end extends through the end of the conductor tube, secure the conduit retaining nut at the plug to prevent its backward movement.

NOTE 4

When the conduit is fully inserted into the cable assembly and the conduit stop is firmly against the Connector Plug, the "raw end" of the conduit will protrude out of the open end of the torch conductor tube. Trim the conduit to 34mm. The trimmed end which seats in the Gas Diffuser must be filed and reamed smooth on the inside and outside radii so wire feed will not be obstructed.

- d) Replace Gas Diffuser, Contact Tip, and Nozzle.
- e) Tighten the Allen screw in the conductor tube.

11.07 MIG Torch Maintenance

Remove dust and metallic particles from the torch conduit by forcing clean, dry compressed air into the conduit once a week. This will minimise wire feeding problems.

SECTION 12: Basic Welding Technique

12.01 Setting of the Power Source & Wirefeeder

Power source and Wirefeeder setting requires some practice by the operator, as the welding plant has two control settings that have to balance. These are the Wirespeed control and the welding Voltage Control. The welding current is determined by the Wirespeed control, the current will increase with increased Wirespeed, resulting in a shorter arc. Less wire speed will reduce the current and lengthen the arc. Increasing the welding voltage hardly alters the current level, but lengthens the arc. By decreasing the voltage, a shorter arc is obtained with a little change in current level.

When changing to a different electrode wire diameter, different control settings are required. A thinner electrode wire needs more Wirespeed to achieve the same current level.

A satisfactory weld cannot be obtained if the Wirespeed and Voltage settings are not adjusted to suit the electrode wire diameter and the dimensions of the work piece.

If the Wirespeed is too high for the welding voltage, "stubby" will occur as the wire dips into the molten pool and does not melt. Welding in these conditions normally produces a poor weld due to lack of fusion. If, however, the welding voltage is too high, large drops will form on the end of the wire, causing spatter. The correct setting of voltage and Wirespeed can be seen in the shape of the weld deposit and heard by a smooth regular arc sound.

12.02 Position of MIG Torch

The angle of MIG torch to the weld has an effect on the width of the weld.

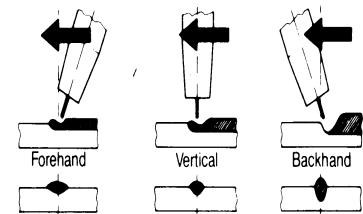

12.03 Distance from the MIG Torch Nozzle to the Work Piece

The electrode wire stick out from the MIG Torch nozzle should be between 10mm to 20.0mm. This distance may vary depending on the type of joint that is being welded.

12.04 Travel Speed

The speed at which the molten pool travels influences the width of the weld and penetration of the welding run.

12.05 Electrode Wire Size Selection

The choice of Electrode wire size and shielding gas used depends on the following

- Thickness of the metal to be welded
- Type of joint
- Capacity of the wire feed unit and Power Source
- The amount of penetration required
- The deposition rate required
- The bead profile desired
- The position of welding
- Cost of the wire

Weld metal deposition rate is proportional to current density. Current density is defined as the current per cross sectional area of the electrode wire and is normally expressed as amps per mm². An example is shown below

Electrode Wire Size mm (inch)	Current	Current Density (A/mm ²)	Deposition Rate (kg/hour)
0.9 (0.035)	200A	314	3.2
1.2 (0.045)	200A	177	2.8

Table 13 – Electrode Wire Deposition Rate

TRANSMIG 275 MIG Power Source

This demonstrates that where the upper limit of current is limited by machine capacity and duty cycle, higher deposition rates and therefore greater productivity will be achieved by using smaller electrode wire. The TRANSMIG is a particularly efficient MIG welder with the 0.9mm steel wire in spray transfer mode. The savings from decreased welding time will more than cover the small cost penalty of the smaller electrode wire sizes. (0.9mm wire cost approximately 10% more than 1.2mm, but is deposited approximately 15% faster).

Higher current density (or smaller diameter wire) also gives deeper penetration

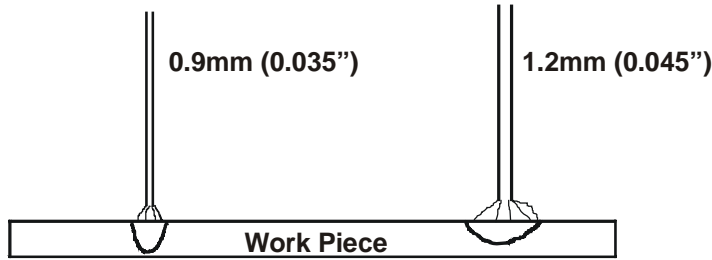

Penetration comparison using 200A for both electrodes

SECTION 13: Routine Maintenance & Inspection

The only routine maintenance required for the TRANSMIG 275 MIG Power Source is a thorough cleaning and inspection, with the frequency depending on the usage and the operating environment.



WARNING 9

There are dangerous voltage and power levels present inside this product. Do not attempt to open or repair unless you are a qualified electrical tradesperson. Disconnect the Wirefeeder from the Welding Power Source and the Welding Power Source from the Mains Supply Voltage before disassembling.

Special maintenance is not necessary for the control unit parts in the Power Source. If these parts are damaged for any reason, replacement is recommended.

CAUTION 4

Do not blow air into the Power Source during cleaning. Blowing air into the Power Source can cause metal particles to interfere with sensitive electronic components and cause damage to the Power Source.

To clean the Power Source, disconnect it from the Mains Supply then open the enclosure and use a vacuum cleaner to remove any accumulated dirt and dust. The Power Source should also be wiped clean. If necessary, solvents that are recommended for cleaning electrical apparatus may be used.

Troubleshooting and repairing the TRANSMIG 275 MIG Power Source should be carried out only by those who are familiar with electrical equipment.

13.01 Cleaning the Feed Rolls

Clean the grooves in the drive rolls frequently. This can be done by using a small wire brush. Also wipe off, or clean the grooves on the upper feed roll. After cleaning, tighten the feed roll retaining knobs.

13.02 Improved Accuracy for the Digital Meter



WARNING 10

This calibration procedure should be carried out by a qualified electrical tradesperson.

The following procedure will give a current measurement accuracy of better than the factory standard of approximately 5%.

Equipment Required:	TRANSMIG 275
DC Ammeter (certified up to $\pm 1\%$ accuracy)	300A
LOAD RESISTANCE of 0.1Ω	8kW
Output Connecting Leads	✓

- With the TRANSMIG 275 MIG Power Source switched off, connect the LOAD RESISTANCE and DC AMMETER to the output terminals.

TRANSMIG 275 MIG Power Source

- b) Open the wirefeeder compartment door or remove the left-hand side cover (when viewing the TRANSMIG 275 MIG Power Source from the front).
- c) Select maximum voltage switch positions: Coarse HIGH Fine 8
- d) Switch the Mains supply voltage to the TRANSMIG 275 MIG Power Source ON.
- e) Ensure the DIGITAL METER is selected to read current.
- f) Short circuit the TORCH TRIGGER terminals to energise output welding terminals.

CAUTION 5

Do not allow the TRANSMIG 275 MIG Power Source to remain ON under load for more than 1 minute!

- g) Determine the output current as given by the DC AMMETER.
- h) Adjust SHUNT CAL. potentiometer on DIGITAL METER to read identically with DC AMMETER.
- i) Open circuit the TORCH TRIGGER terminals to deactivate output welding terminals.
- j) Select minimum voltage switch positions: Coarse LOW Fine 1
- k) Short circuit the TORCH TRIGGER terminals to energise output welding terminals. Refer to CAUTION 5.
- l) Determine output current as given by the DC AMMETER.
- m) Confirm the minimum DIGITAL METER reading is within $\pm 2\%$ of DC AMMETER.
- n) If the above is not met, offset the SHUNT CAL. potentiometer such that both the minimum and maximum values are within $\pm 2\%$.
- o) The improved accuracy for DIGITAL METER is now complete.
- p) Where fitted, position the meter cover over the hexagonal brass spacers taking care not to trap loom wiring.
- q) Fit the M3 flat washers and M3 screws through the meter cover and into the hexagonal brass spacers.
- r) Close wire-feeder compartment or replace side panel.

SECTION 14: Basic Troubleshooting



WARNING 11

There are dangerous voltage and power levels present inside this product. Do not attempt to open or repair unless you are a qualified electrical tradesperson and you have had training in power measurements and troubleshooting techniques.

If major complex subassemblies are faulty, then the Welding Power Source must be returned to an Accredited CIGWELD Service Agent for repair.

The basic level of troubleshooting is that which can be performed without special equipment or knowledge and without removing the covers from the Wirefeeder.

14.01 Solving Problems Beyond the Welding Terminals

The general approach to fix Gas Metal Arc Welding (GMAW) problems is to start at the wire spool then work through to the MIG torch. There are two main areas where problems occur with GMAW, Porosity and Inconsistent wire feed

14.02 Solving Problems Beyond the Welding Terminals - Porosity

When there is a gas problem the result is usually porosity within the weld metal. Porosity always stems from some contaminant within the molten weld pool which is in the process of escaping during solidification of the molten metal. Contaminants range from no gas around the welding arc to dirt on the work piece surface. Porosity can be reduced by checking the following points.

TRANSMIG 275 MIG Power Source

FAULT	CAUSE
1 Gas cylinder contents and flow meter.	Ensure that the gas cylinder is not empty and the flow meter is correctly adjusted to 15 litres per minute.
2 Gas leaks.	Check for gas leaks between the regulator/cylinder connection and in the gas hose to the Power Source.
3 Internal gas hose in the Power Source.	Ensure the hose from the solenoid valve to the torch adaptor has not fractured and that it is connected to the torch adaptor.
4 Welding in a windy environment.	Shield the weld area from the wind or increase the gas flow.
5 Welding dirty, oily, painted, oxidised or greasy plate.	Clean contaminates off the work piece.
6 Distance between the MIG torch nozzle and the work piece.	Keep the distance between the MIG torch nozzle and the work piece to a minimum. Refer to section 11.03 on page 21.
7 Maintain the MIG torch in good working order.	A Ensure that the gas holes are not blocked and gas is exiting out of the torch nozzle. B Do not restrict gas flow by allowing spatter to build up inside the torch nozzle. C Check that the MIG torch O-rings are not damaged.

CAUTION 6

Disengage the drive roll when testing for gas flow by ear.

14.03 Solving Problems Beyond the Welding Terminals – Inconsistent Wire Feed

Wire feeding problems can be reduced by checking the following points.

FAULT	CAUSE
1 Wire spool brake is too tight	Feed roller driven by motor in the cabinet will slip.
2 Wire spool brake is too loose	Wire spool can unwind and tangle.
3 Worn or incorrect feed roller size	A Use 'U' groove drive feed roller matched to the aluminium wire size you are welding. B Use 'V' groove drive feed roller matched to the hard wire size you are welding. C Use 'knurled V' groove drive feed roller matched to the flux cored wire size you are welding.
4 Mis-alignment of inlet/outlet guides	Wire will rub against the mis-aligned guides and reduces wire feedability.
5 Liner blocked with swarf	A Increased amounts of swarf are produced by the wire passing through the feed roller when excessive pressure is applied to the pressure roller adjuster. B Swarf can also be produced by the wire passing through an incorrect feed roller groove shape or size. C Swarf is fed into the conduit liner where it accumulates thus reducing wire feedability.
6 Incorrect or worn contact tip	A The contact tip transfers the weld current to the electrode wire. If the hole in the contact tip is too large then arcing may occur inside the contact tip resulting in the wire jamming in the contact tip B When using soft wire such as aluminium it may become jammed in the contact tip due to expansion of the wire when heated. A contact tip designed for soft wires should be used.
7 Poor work lead contact to work piece	If the work lead has a poor electrical contact to the work piece then the connection point will heat up and result in a reduction of power at the arc.
8 Bent liner	This will cause friction between the wire and the liner thus reducing wire feedability

TRANSMIG 275 MIG Power Source

14.04 Welding Problems

FAULT	CAUSE	REMEDY
1 Undercut	A Welding arc voltage too high. B Incorrect torch angle C Excessive heat input	A Reduce voltage by reducing the Voltage Control switch positions or turn the Wirespeed control knob anticlockwise. B Adjust angle C Increase the torch travel speed or reduce welding current by reducing the Voltage Control switch positions and turn the Wirespeed control knob anticlockwise.
2 Lack of penetration	A Welding current too low B Joint preparation too narrow or gap too tight C Shielding gas incorrect	A Increase welding current by increasing the Wirespeed control knob clockwise and increasing Voltage Control switch positions. B Increase joint angle or gap C Change to a gas which gives higher penetration
3 Lack of fusion	Arc voltage to low	Increase Arc voltage by increasing the Voltage Control switch positions.
4 Excessive spatter	A Arc voltage too high B Arc voltage too low	A Lower voltage by reducing the Voltage Control switch positions or turn the Wirespeed control knob anti-clockwise. B Raise voltage by increasing the Voltage Control switches or turn the Wirespeed control knob clockwise.
5 Irregular weld shape	A Incorrect voltage and current settings. Convex, Arc voltage too low Concave, voltage too high B Wire is wandering C Incorrect shielding gas D Insufficient or excessive heat input	A Adjust voltage and current by adjusting the Voltage Control switch positions and the Wirespeed control knob. B Replace contact tip C Check gas selection D Adjust the Wirespeed control knob or the Voltage Control switch.
6 Arc does not have a crisp sound that short arc exhibits when the wirefeed speed and voltage are adjusted correctly	The MIG torch has been connected to the wrong voltage polarity on the front panel	Connect the MIG torch to the positive welding terminal (+) for solid wires and gas shielded flux cored wires.
7 Weld cracking	A Weld beads too small B Weld penetration narrow and deep C Excessive weld stresses D Excessive voltage E Cooling rate too fast	A Decrease torch travel speed B Reduce current and voltage and increase the MIG Torch travel speed or select a lower penetration shielding gas. C Increase weld metal strength or revise design D Decrease voltage by reducing the Voltage Control switches. E Slow the cooling rate by preheating part to be welded or cool slowly.
8 Cold weld puddle	A Faulty rectifier unit B Loss of a phase in the Mains supply voltage. C Loose welding cable connection. D Low Mains supply voltage	A Have an Accredited CIGWELD Service Agent test then replace the faulty component. B Check mains power C Check all welding cable connections. D Contact supply authority

14.05 Power Source / Wirefeeder Problems

FAULT	CAUSE	REMEDY
1 Indicator light is ON but welding arc can not be established.	Power Source is in the <i>STANDBY</i> position.	Set the Power Source to a welding setting.
2 Mains supply voltage is ON. Indicator light is not lit and welding arc can not be established.	A Primary fuse is blown. B Broken connection in primary circuit.	A Replace primary fuse. B Have an Accredited CIGWELD Service Agent check primary circuit.
3 Mains indicator light is not lit but welding arc can be established.	Burnt out Indicator light.	Have an Accredited CIGWELD Service Agent replace Indicator light.
4 Mains supply voltage is ON and Indicator light is lit but when the torch trigger switch is depressed nothing happens.	A Torch trigger switch leads are disconnected. B Circuit breaker tripped	A Re connect Torch trigger switch leads B Reset Circuit Breaker(s)
5 Mains supply voltage is ON, no wire feed but gas flows from the MIG Torch when the torch trigger switch is depressed.	A Electrode wire stuck in conduit liner or contact tip (burn-back jam). B Faulty control PCB	A Check for clogged / kinked MIG Torch conduit liner or worn contract tip. Replace faulty components. B Have an Accredited CIGWELD Service Agent investigate the fault.
6 Wire feeds when the torch trigger switch is depressed but arc can not be established.	Poor or no work lead contact.	Clean work clamp area and ensure good electrical contact.
7 Jerky wire feed	A Worn or dirty contact tip B Worn feed roll. C Excessive back tension from wire reel hub. D Worn, kinked or dirty conduit liner	A Replace B Replace C Reduce brake tension on spool hub D Clean or replace conduit liner
8 No gas flow	A Gas hose is cut. B Gas passage contains impurities. C Gas regulator turned off. D Empty Cylinder	A Replace or repair. B Disconnect gas hose from the rear of Power Source or wirefeeder then raise gas pressure and blow out impurities. C Turn on. D Replace cylinder.
9 Gas flow continues after the torch trigger switch has been released.	Gas valve has jammed open due to impurities in the gas or the gas line.	Have an Accredited CIGWELD Service Agent repair or replace gas valve.
10 Wire does not feed when torch trigger depressed	A Faulty trigger switch / lead B Circuit breaker tripped	A Repair or replace Torch / trigger lead B Reset Circuit Breaker(s)
11 Wire continues to feed when torch trigger released	A Wirefeeder in 4T (LATCH) mode B Torch trigger leads shorted	A Change to 2T (NORMAL) mode B Repair or replace Torch / trigger lead
12 Wire feeds when the torch trigger switch is depressed but arc can not be established and OVERTEMPERATURE led is illuminated	Power Source Overtemperature Protection circuit has operated	Cease welding and allow Power Source to Cool for 10 minutes. Overtemperature led will extinguish when the Power Source has cooled sufficiently.

TRANSMIG 275 MIG Power Source

SECTION 15: Key Spare Parts

Cigweld Part Number	Description	Cigweld Part Number	Description
707532PKD	Main Welding Transformer	706770PKD	Inductor Assembly
7978001	Contactora	7977962PKD	Rectifier 275A
7978050PKD	Control pcb	7977178	Capacitor 22,000uF 63V
7977965PKD	Timer pcb	7977951PKD	Coarse Rotary Voltage Switch
7977867	Solenoid Valve	7977950PKD	Fine Rotary Voltage Switch
702337	Wire Reel Hub	7977985	Wire Drive Assembly
7977884	Switch / Indicator 240V		
7977932PKD	Fan Assembly	704460	Welding Current DINSE Terminal
210254	Regulator Argon 55lpm 2G	704461	Work Lead DINSE Plug

Table 14 – Key Spare Parts



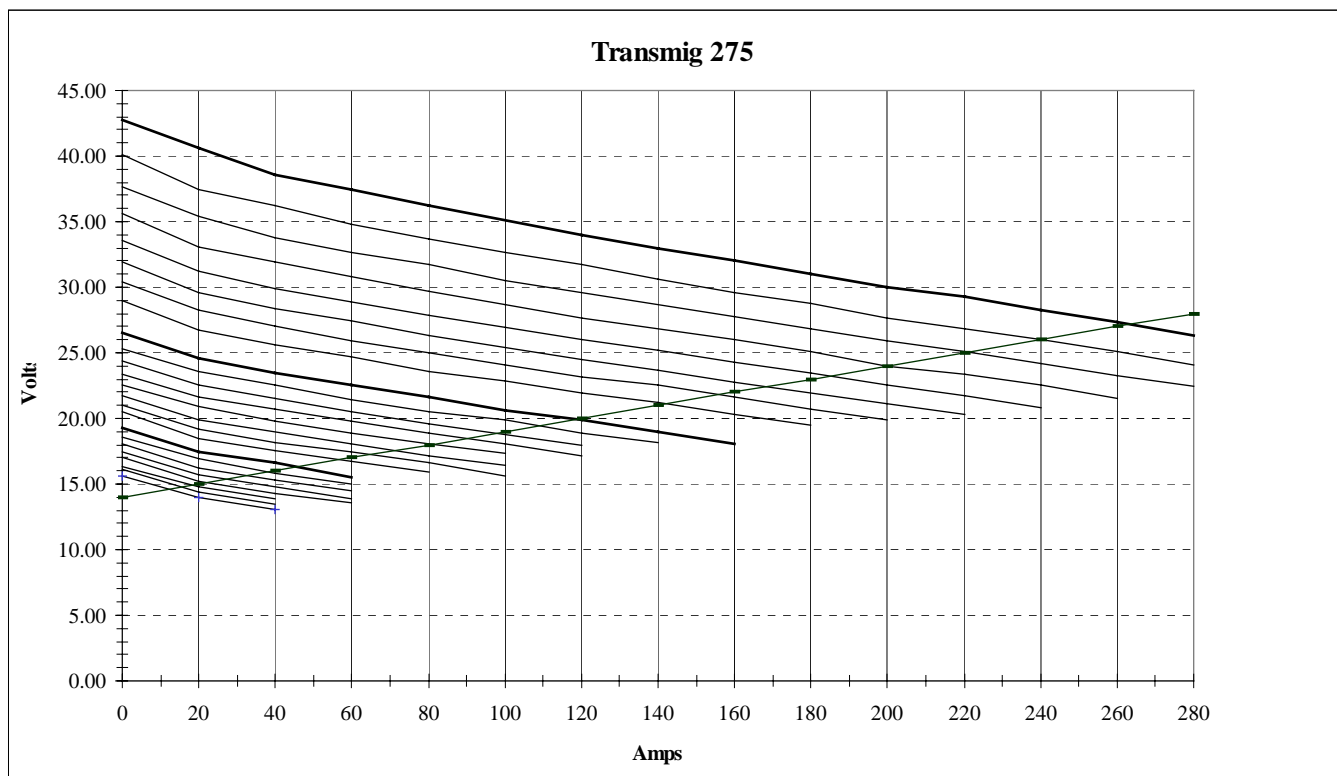













SECTION 16: Volt / Amp Curves



TRANSMIG 275 MIG Power Source

SECTION 18: Weld Settings Guide

TRANSMIG 275

SETTING SELECTION GUIDE			PLATE THICKNESS MILD STEEL						
SHIELDING GAS	WELDING WIRE	CONTROL SETTINGS	0.6 mm	1 mm	1.6 mm	3 mm	5 mm	6 mm	10 mm
									
100% CO ₂	0.6mm SOLID	COARSE FINE WIRESPEED		L 7 3.5	M 7 9	H 1 11	H 3 15	USE 0.8MM	USE CORED WIRE
	0.8mm SOLID	COARSE FINE WIRESPEED		L 5 3	M 1 4	M 6 6.5	H 3 9	H 6 12	USE CORED WIRE
	0.9mm SOLID	COARSE FINE WIRESPEED		M 1 3	M 5 4	H 1 6.5	H 6 9	H 6 10.5	USE CORED WIRE
	1.0mm SOLID	COARSE FINE WIRESPEED			M 5 4	H 3 7.5	H 6 10	H 8 12	USE CORED WIRE
	1.2mm CORED	COARSE FINE WIRESPEED				H 3 6	H 6 8	H 6 9	H 8 9
91.9% Ar 5.0% CO ₂ 3.1 % O ₂	0.6mm SOLID	COARSE FINE WIRESPEED		L 1 3.5	L 8 5.5	M 5 9.5	M 8 15.5	USE 0.8MM	USE 0.8MM
	0.8mm SOLID	COARSE FINE WIRESPEED		L 5 3.5	L 8 5	M 4 7.5	H 2 12.5	H 5 13	H 6 15
	0.9mm SOLID	COARSE FINE WIRESPEED		L 6 3.5	L 8 4.5	M 7 7.5	H 3 10	H 5 11	H 7 13
	1.0mm SOLID	COARSE FINE WIRESPEED			M 2 5	M 5 5.5	H 3 8.5	H 4 9	H 8 13
	1.2mm CORED	COARSE FINE WIRESPEED				H 1 5.5	H 4 8	H 4 8	H 8 12
Gasless Wire	1.2mm CORED	COARSE FINE WIRESPEED			L 7 2	M 3 4	H 2 6	H 2 6	H 6 10
SETTING SELECTION GUIDE			PLATE THICKNESS STAINLESS STEEL						
SHIELDING GAS	WELDING WIRE	CONTROL SETTINGS	1 mm	1.2 mm	1.6 mm	3 mm	5 mm	6 mm	
									
98% Ar 2% O ₂	0.9mm SOLID	COARSE FINE WIRESPEED	L 5 3	L 6 4	L 7 4	M 6 9	H 5 12.5	H 5 12.5	
	1.2mm SOLID	COARSE FINE WIRESPEED		M 1 3.5	M 6 5	M 8 7	H 3 10	H 3 10	
SETTING SELECTION GUIDE			PLATE THICKNESS ALUMINIUM				COARSE VOLTAGE SETTINGS L = LOW M = MEDIUM H = HIGH		
SHIELDING GAS	WELDING WIRE	CONTROL SETTINGS	1.6mm	3 mm	5 mm	6 mm			
									
98% Ar 2% O ₂	1mm SOLID	COARSE FINE WIRESPEED	L 8 8	M 5 13	H 3 16	H 3 16			
	1.2mm SOLID	COARSE FINE WIRESPEED	L 8 6.5	M 5 10	H 2 12	H 2 12			

NOTES

TRANSMIG 275 MIG Power Source

Distributed by:

Manufacturer and Supplier of Welding Consumables and Equipment

CIGWELD

THERMADYNE®

CIGWELD Pty. Ltd. A.C.N. 007 226 815
71 Gower Street, Preston, Victoria, Australia 3072
Telephone: (03) 9474 7400 Facsimile: (03) 9474 7391

Customer Service & Technical Support Line: 1300 654 674
International Enquiries: Telephone +61 3 9474 7508
Facsimile: +61 3 9474 7488

In the interest of continuous improvement, CIGWELD Pty. Ltd. reserves the right to change the specifications or design of any of its products without prior notice.

© Copyright 2007

719547-02-308
